

SPECIFICATIONS

DIAMETER:	15" (381.0 mm)
SENSITIVITY (2.83 V @ 1 m):	97 dB
POWER HANDLING:	350 W _{RMS}
FREQUENCY RESPONSE:	18 ~ 350 Hz
NOMINAL IMPEDANCE:	4 OHMS
VOICE-COIL DIAMETER:	3.18" (80.8 mm)
DIMENSIONS:	

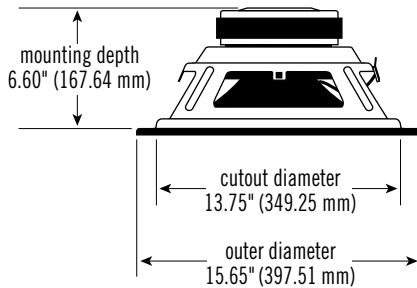

THIELE-SMALL PARAMETERS

VOICE COIL DC RESISTANCE:	R_{EVC} (OHMS)	3.21
VOICE COIL INDUCTANCE @ 1 kHz:	L_{EVC} (MH)	3.08
DRIVER RADIATING AREA:	S_D (IN ²)	127.93
	S_D (CM ²)	829.00
MOTOR FORCE FACTOR:	BL (TM)	16.48
COMPLIANCE VOLUME:	V_{AS} (FT ³)	12.20
	V_{AS} (LITERS)	287.90
SUSPENSION COMPLIANCE:	C_{MS} (µM/N)	295.00
MOVING MASS, AIR LOAD:	M_{MS} (GRAMS)	144.34
MOVING MASS, DIAPHRAGM:	M_{MD} (GRAMS)	130.62
FREE-AIR RESONANCE:	F_S (Hz)	24.39
MECHANICAL Q:	Q_{MS}	5.82
ELECTRICAL Q:	Q_{ES}	0.26
TOTAL Q:	Q_{TS}	0.25
MAGNETIC-GAP HEIGHT:	H_{AG} (IN)	0.35
	H_{AG} (MM)	9.00
VOICE-COIL HEIGHT:	H_{VC} (IN)	0.79
	H_{VC} (MM)	20.00
MAXIMUM EXCURSION:	X_{MAX} (IN)	0.39
	X_{MAX} (MM)	10.0

IMPEDANCE CURVE

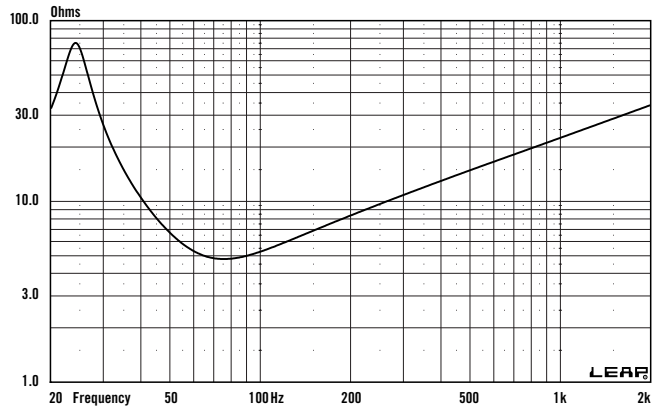

INFINITE Baffle FREQUENCY RESPONSE @ 2.83 V

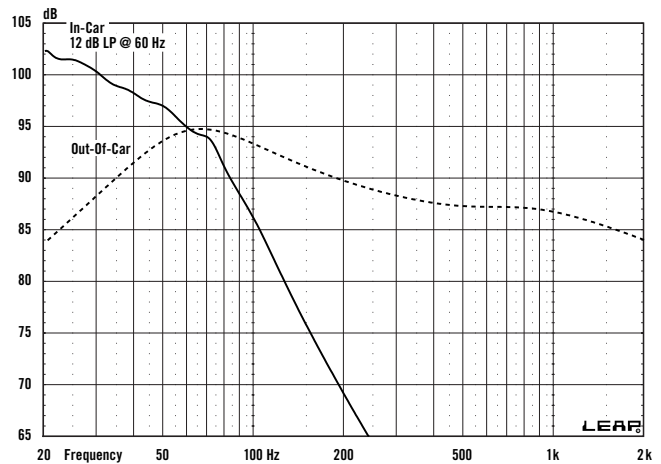

INFINITE Baffle EXCURSION/GROUP DELAY @ 250 W

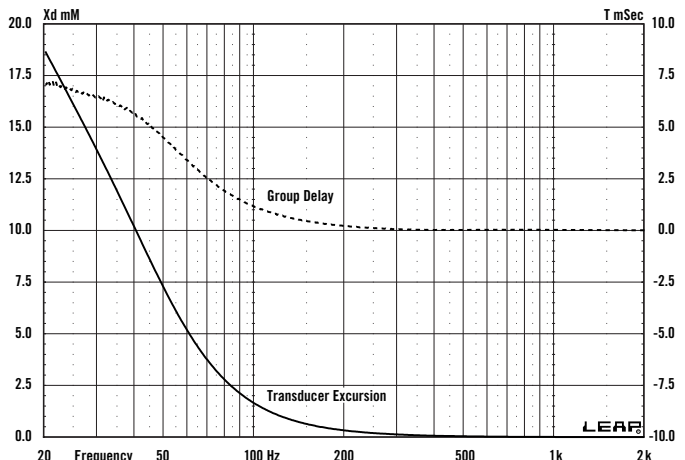

SEALED BOX VOLUME

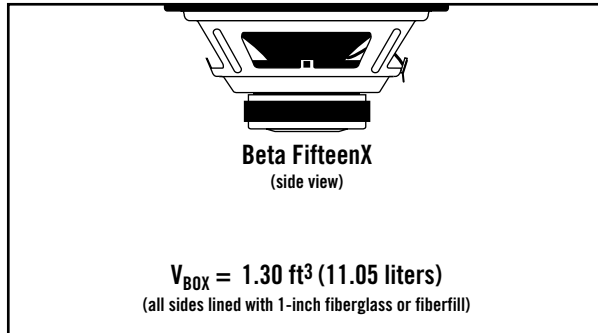

VENTED BOX VOLUME

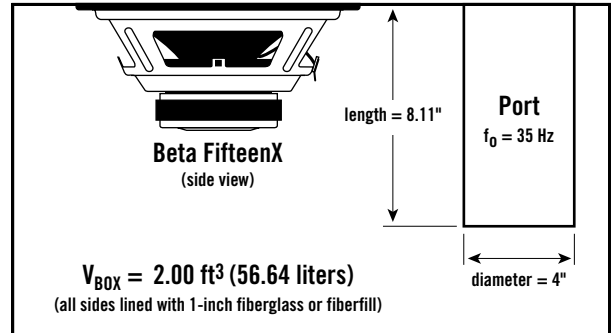

SEALED FREQUENCY RESPONSE @ 2.83 V

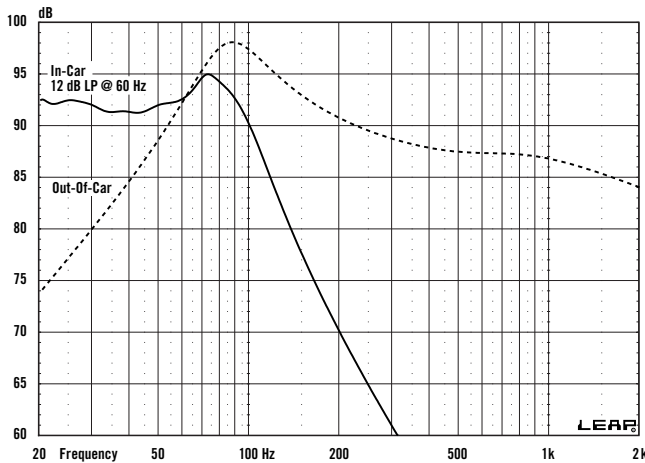

VENTED FREQUENCY RESPONSE @ 2.83 V

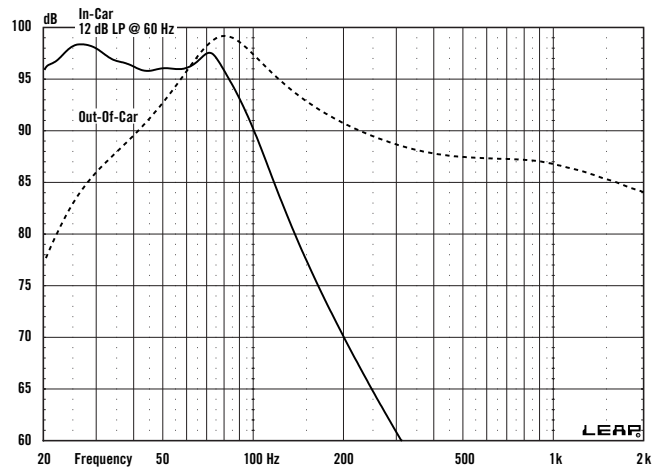

SEALED EXCURSION/GROUP DELAY @ 1000 W

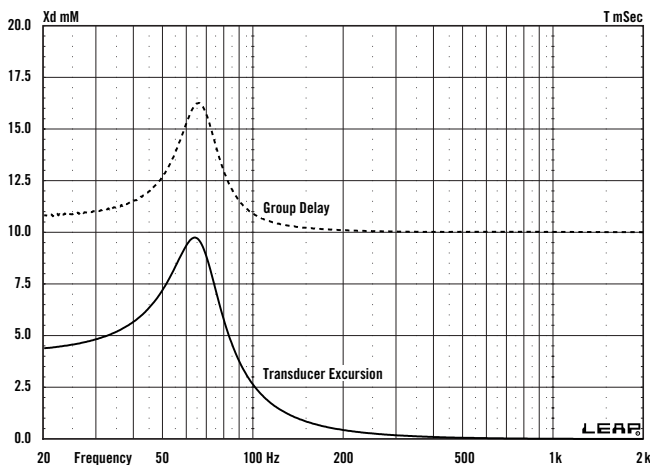

VENTED EXCURSION/GROUP DELAY @ 1100 W

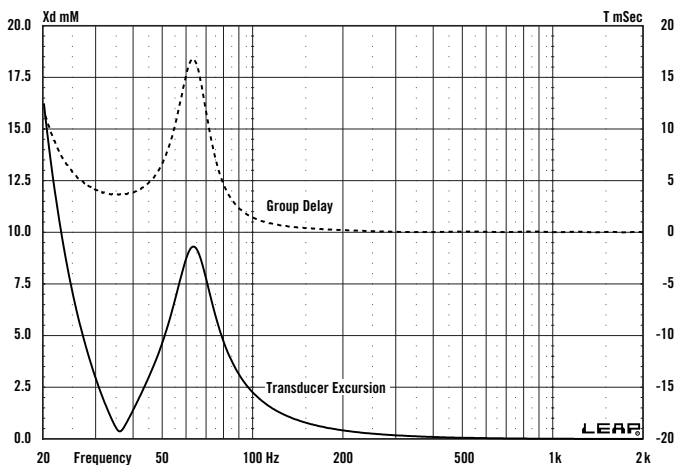

SEALED BANDPASS BOX VOLUME

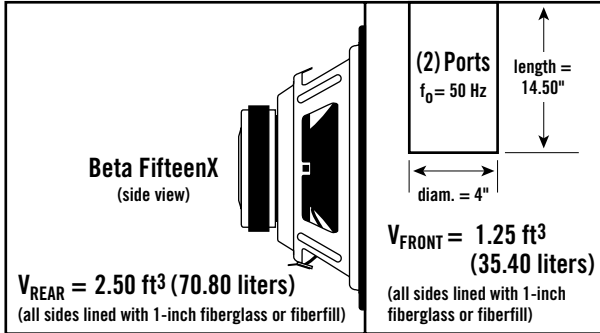

NOTES

SEALED BANDPASS FREQUENCY RESPONSE @ 2.83 V

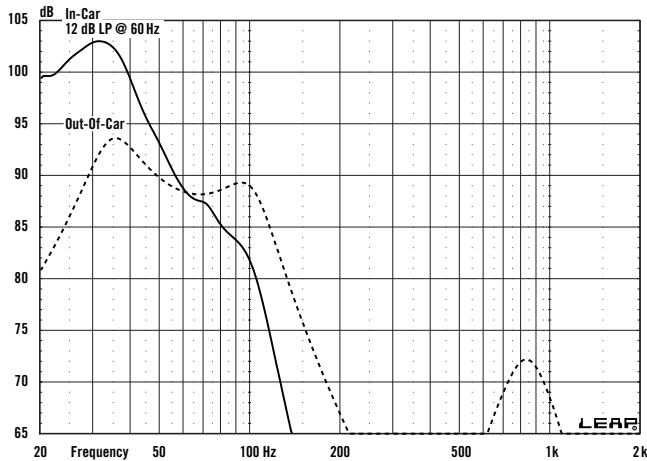

SEALED BANDPASS EXCURSION/GROUP DELAY @ 700 W

